

IP54 : Suitable for Wet Locations  
 IK07 : Impact Resistant (Vandal Resistant)

## UMN-91186-SC60

### Martini 13 small single area light type IV

Small and medium size modern shape area light distribution for metal halide lamps or sodium vapour discharge lamps 70-400w and LED. A high quality reflector design creates broad spread light distribution. Main application for lighting of public, private roadways, car parks, exhibition areas, service stations, truck stop and sports grounds. Aluminium housing with high corrosion resistance. Integral control gear. Stainless steel screws. Durable silicone rubber gasket and clear toughened glass with hinge aluminium frame for in-position lamp replacement. Anodized high purity aluminium reflector. Main housing is powder paint with high corrosion resistance with chemical chromated protection.

#### Physical Data

Length: 22.5"  
 Height: 5.9"  
 Weight: 23.1 lbs

#### Lamp

HPS-ED17 150w

(For More Lamp options including LED, please Consult the Catalogue, Website or Contact The Ligman Lighting Factory)

#### Voltage (Please Specify)

120V  
 277V  
 Other \_\_\_\_\_

#### Options (Please Specify)

##### Color (Please Specify)

01-Black - RAL 9011       02- Dark Grey - RAL 7043  
 03-White - RAL 9003       04 - Metallic Silver - RAL 9006  
 05-Matt Silver - RAL 9006       07- Custom - RAL \_\_\_\_\_  
 06-Bronze - RAL 6014

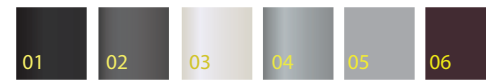

Frosted Lens

Clear Lens

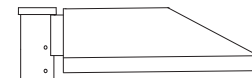

Straight Arm 0° Tilt (Dark Sky Compliant)



Single Banner Arm

Double Banner Arm

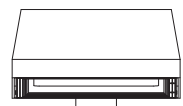
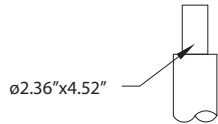
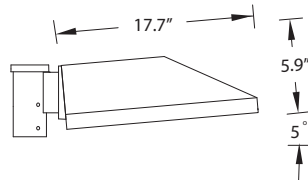
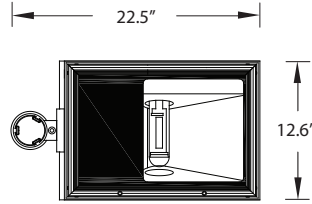
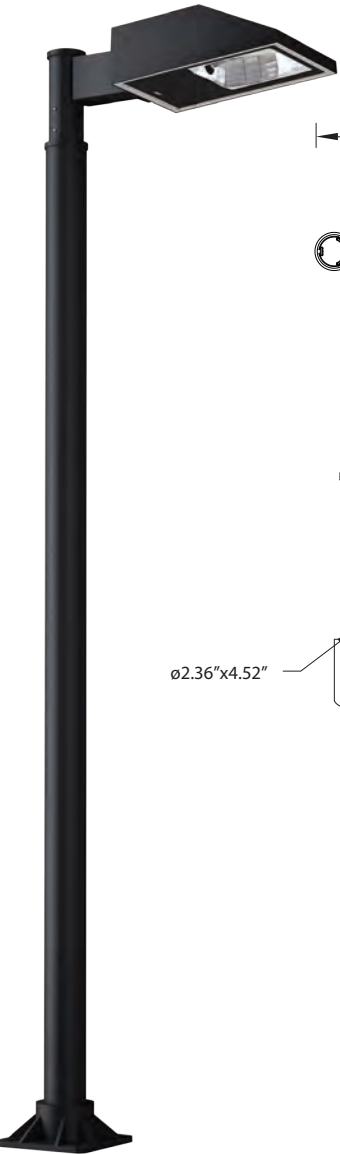
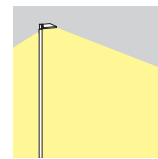

Ordering Example : UMN - 91186-SC60 - HPS-150w - 120v - Options

PROJECT: \_\_\_\_\_ DATE: \_\_\_\_\_

TYPE: \_\_\_\_\_ QUANTITY: \_\_\_\_\_ NOTE: \_\_\_\_\_

Ligman Lighting USA reserves the right to change specifications without prior notice, please contact factory for latest information. Due to the continual improvements in LED technology data and components may change without notice.

